

Please mark clearly with an X the items you wish to purchase.
 Email form to NuVision Rehab Group at sales@nuvisionrehab.com or fax form to 403-253-1744.
 Contact our customer service team at (877) 252-6655.

Account #: _____	Ship to: _____
Date: _____	Name: _____
PO #: _____	Address: _____
Buyer: _____	City: _____
Attention: _____	Phone: () _____

Soft, Contoured Portable Potty Seat

The Portable Potty Seat comes complete with a draw cord backpack for easy portability. The backpack has a plastic lining for hygienic purposes. There is also an outside pocket that can hold wipes or any other necessities. The Potty Seat fits into the draw cord backpack for a complete "on-the-go" solution.

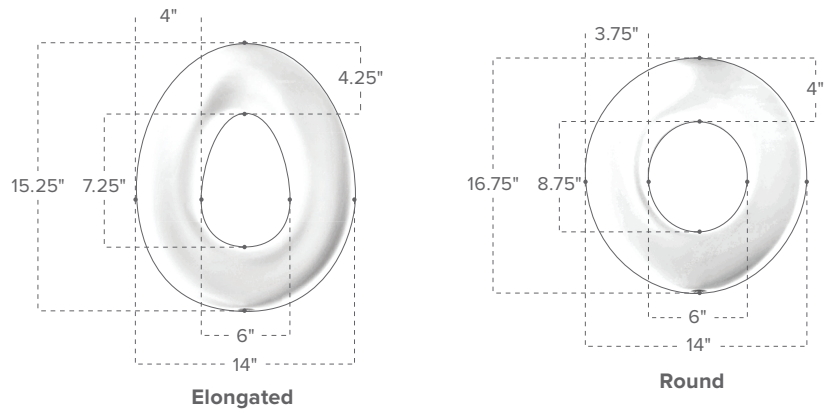

Item	Cherry	Lilac	Lime	Aqua	Dark Gray	Light Gray	MSRP
Round Seat Cushion	74010001	74010002	74010003	74010004	74010009	74010010	\$ 243.42
Elongated Seat Cushion	74020001	74020002	74020003	74020004	74020009	74020010	\$ 324.56



Draw Cord backpack included.
 Fits on most Push Chairs.

